

USER MANUAL

brainLight®-Shiatsu-Massage-Chair

Gravity PLUS



brainLight®

LIFE IN BALANCE

brainLight®-Shiatsu-Massage-Chair Gravity PLUS

Thank you very much for purchasing the **brainLight**-Shiatsu-Massage-Chair Gravity PLUS! The Gravity PLUS will indulge you with different massage techniques in your neck, back, lower body and calf areas. For optimal blood circulation and spinal relief the fully automatic recline and rocking positions are available to you. The Auto and Relax massage programs relax your whole body automatically; alternatively, you can individually adjust your massage experience and tailor it to your desires.

In order to enjoy your massage chair to its full potential, please read this users manual carefully before using it, especially for its safety instructions.

© 2023 **brainLight** – All rights reserved.

No part of this work may be reproduced in any form (print, scan, photocopy, microfilm or any other method) without written permission by **brainLight** GmbH and no part of this work may be processed or copied using electronic devices.

Contents

General Safety Instructions	3
Massage Chair Components	6
Setup Instructions	8
Remote Control	11
Massage and Remote Control Functions	12
General Instructions for Use	19
Troubleshooting, Maintenance & Care	21
Product Specifications	23

Warranty and Guarantee

The warranty and guarantee periods adhered to by **brainLight** are as follows:

Private customers:

- 24 months warranty for new goods.
- 12 months warranty for used goods.
- 24 months guarantee for new goods.
- 6 months guarantee for used goods.

Commercial customers:

- 12 months warranty for new goods.
- 6 months warranty for used goods.
- 6 months guarantee for new and used goods.

General Safety Instructions

To prevent any damage, accident or injury, please pay attention to the following safety instructions:

1. People with any of the following conditions are advised to consult their physician or therapist before using the chair:

- People with heart diseases
- People with malignant tumors
- Women during pregnancy and menstruation
- People with abnormalities or curvature of the spine
- People under medical treatment
- People with osteoporosis.

People suffering from thrombosis or similar vein conditions are advised not to use the calf massage functions.

Children, people with relevant disabilities or illnesses should only use the chair under the supervision of an adult or carer.

People weighing more than 120 kg / 19 stone / 265 lbs are not permitted to use the chair.

2. Installation and Operation:

- Position the chair only on a flat, level surface.
- Do not set up the chair in a dirty, oily, humid or damp environment.
- Do not expose the chair to direct sunlight and do not place it too close to other electrical appliances.

3. Before use:

Please read the safety instructions carefully before using your chair.



General Safety Instructions

4. During use

- Do not let children play on the chair.
- Children under 14 years should not use the chair.
- Keep hands and feet away from the mechanics of the chair.
- Please do not stand on the calfcrest in order to prevent injuries and damage to the chair.
- Dry yourself fully before using the chair (after a bath or shower).
- Sit in the chair in an upright position.
- Do not insert any objects into the mechanics, seat cushion, or calfcrest of the chair.
- The massage chair should not be used by more than one person at a time.
- Do not eat or drink while using the massage chair.
- If you fold back the pillows, be aware that the massage will be stronger in the neck area.
- If you fold the backrest pad backward or remove the foam insert from the backrest pad, the massage intensity will be enhanced.

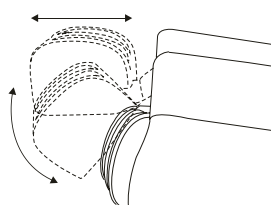

5. After use:

- We recommend to drink plenty of water after every use of the chair – as is recommended after any type of massage – in order to help the removal of toxins and waste from the limbic system.
- Please unplug the power cord from the wall socket when the chair is not in use.

6. Do not dismantle the massage chair without assistance!

- Do not attempt to dismantle, repair, or modify the chair without the technical guidance of **brain-Light** GmbH.
- Do not clean the chair with alcoholic or steam producing solutions.
- Unplug the power cord when cleaning or maintaining the chair.

PLEASE NOTE:

Please regularly check the foam insert (attached with velcro) and the fabric cover (attached to the back frame with a zip) beneath the backrest of your massage chair. In order to ensure optimum performance and to avoid damage, the foam insert and the fabric cover must be replaced after 1000 uses, or earlier if they rupture or show signs of severe deterioration.

General Safety Instructions

Caution:

- The **brainLight**-Systems are designed for a voltage of 220V. If your power supply differs from that, you will need a voltage converter in order to use our products.
- Furthermore, we would like to make you aware that if you experience current fluctuations in your country, you should connect any electrical item to a plugbar with overvoltage protection before connecting it to the power grid.
- If you feel unwell or ill when using the chair, pause your session immediately by pushing the STOP button.
- Put a towel underneath your head when using hair gel or oil- or wax-based hair products to protect the cover material of the chair.
- If the leather or the chair's upholstery fabric gets damaged or worn, remove the power plug from the plug socket and contact **brainLight** GmbH.
- Please handle the remote control with care and press the buttons only with dry hands. A light touch with your fingertips is enough to operate the chair. Please do not use any sharp objects to operate the remote control (pens, fingernails, etc.).

The HEAT function

To avoid getting too hot during during a massage program with the HEAT function, we recommend that you wear appropriate clothing and set it to a level that is comfortable for you.

- Children, people with relevant disabilities and people with limited sensory perception should not use the HEAT function to avoid the heat level getting too high.
- Do not use the HEAT function for more than 30 minutes and let it cool down before turning it on again. Continuously using the HEAT function may result in overheating.
- For ideal comfort we recommend to use the HEAT function in combination with the massage functions.
- Please turn the HEAT function off separately before shutting down the chair.

Massage Chair Components

Big Pillow

Small Pillow

Left Side Panel

Backrest Pad

Remote Control

Remote Control Holder

Seat Cushion

Right Side Panel

Calfrest

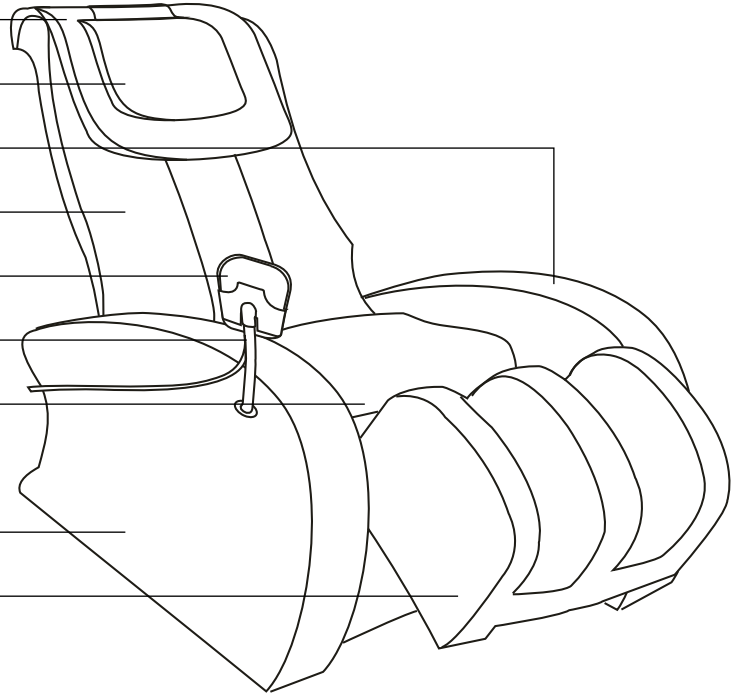

Massage Chair Components

Main Switch Box

ON/OFF Switch

AC Power Cord with Plug

Backrest

Casters

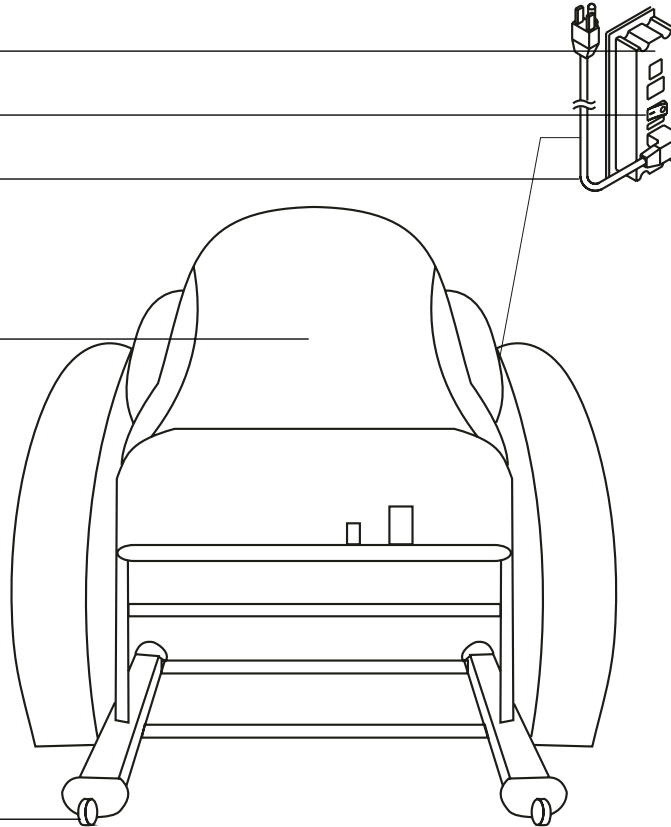

Setup Instructions

If your chair has been delivered by **brainLight** it is already assembled and ready for use. Please proceed as follows if you would like to set up your **brainLight-Shiatsu-Massage-Chair** yourself:

Step 1

Remove the packaging from the chair and the accessories. If you use sharp or pointed tools, make sure not to damage the chair or the accessories.

Step 2

Pull back the backrest until it snaps in with a "click". Fold the backrest pad over to the front of the chair and affix it to the velcro on the seat (if the velcro is covered by a thin plastic protection, remove it first).

Step 3

Put the seat cushion on the seat with the wire facing the backrest.

Step 4

Connect the black wire on the seat cushion with the same colored (black) plug underneath the seat.

Step 1

Seat Cushion Big Pillow

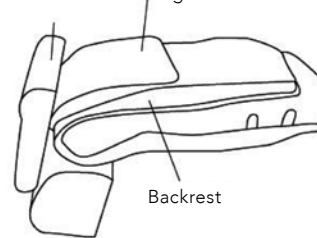

Step 2

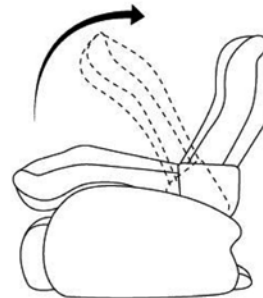

Steps 3 and 4



Step 8



Step 9



Setup Instructions

Step 5

Place the left and right side panels next to the corresponding sides of the chair and connect the green wires to the same colored plugs from underneath the seat.

Step 6

Then screw the side panels to the chair frame. The screws are already attached to the armrests. We recommend that you lightly screw on both upper screws first before attaching the lower screw, and then tighten all of them.

Step 7

Push the seat cushion firmly onto the seat and zip up the front.

Step 8

Attach the big pillow, and on top of that the small pillow, to the velcro at the upper end of the backrest at the desired position.

Step 9

Affix the remote control holder: loosen the two screws on the outside of the right side panel with a cross-tip

screwdriver, line up the remote control holder with the screw holes and then tighten the same two screws again.

Step 10

Connect the remote control wire with the main switch box and put the remote control into the holder.

Step 11

Plug the power cord into the main power switch box on the chair and connect it to a wall socket.

Step 12

Check again to make sure all steps are done properly. The chair is now ready for use.

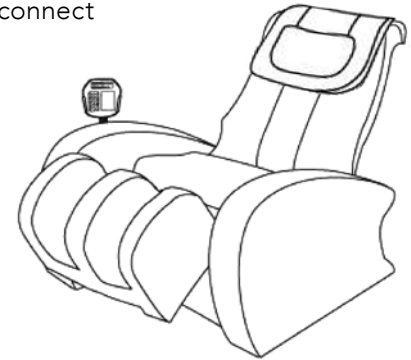

PLEASE NOTE:

If you have any questions concerning the upkeep of your chair please contact **brainLight** GmbH: +49 (0) 6021 59070.

Setup Instructions

Calf Massage Options

Option 1: There are two straps included with the chair. They can be wrapped around the calfrest and secured with velcro.

A) The straps can be used to hold your legs inside the calfrest for a more intense massage.

B) Legs can be placed on top of the straps, if no calf massage is desired.

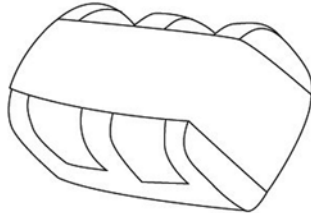

Option 2: The length of the calfrest is set to 8 cm by default. It can be adjusted to 7 cm or 10 cm (2.7-3.9 in) in order to suit different leg lengths: lift up the calfrest and use pinch-nose pliers to take out the safety clip. Remove the bolt shown in the picture on the right. Set the bar to the hole of your preferred length, put the bolt back in and lock it with the safety clip.

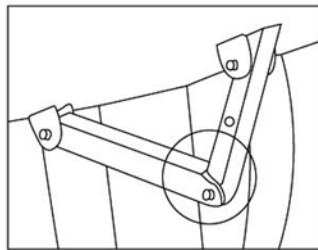

How to move the Chair

Step 1: Make sure the backrest is in its full upright position.

Step 2: Unplug the power cord from the wall outlet.

Step 3: Put your foot on one of the casters.

Step 4: Pull the backrest towards you and push it downwards so that the weight of the chair is shifted onto the casters.

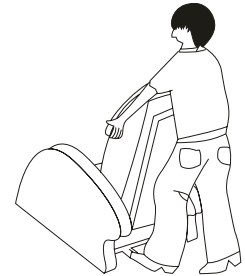

Wheel the chair to the desired place and make sure there is enough space for the backrest to fully recline during the massage.



Remote Control

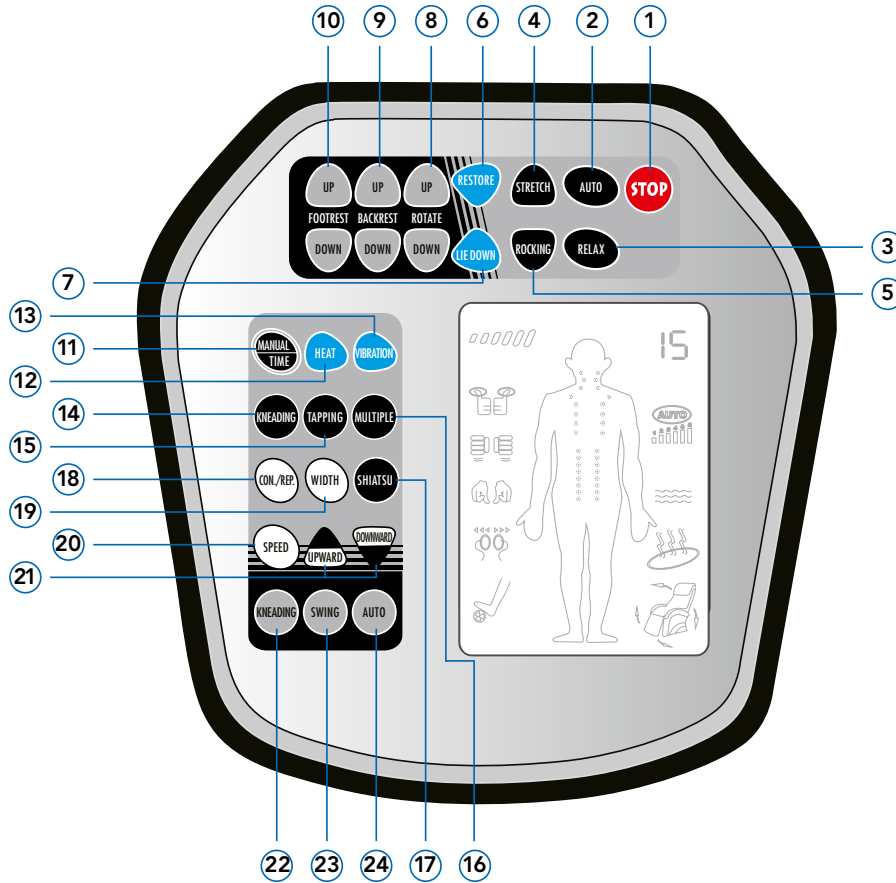

LCD Features

- SPEED
- KNEADING
- TAPPING
- SHIATSU
- WIDTH
- CALF MASSAGE
- 15** TIMER
- AUTO
- VIBRATION
- HEAT

Massage and Remote Control Functions

1 **STOP** STOP Button

Push this button to stop any massage program. The chair and the massage rolls will automatically return to their starting position.

2 **AUTO** AUTO Button

There are six different automatic programs available. Push this button until the program of your choice is shown on the display.

Prior to the massage, the massage rolls move up and down your back to detect your acupressure points.

The preset time for each automated program is 15 minutes; when the program is finished, the chair and the massage rolls automatically return to their starting position.

The AUTO programs have preset speed and width settings for the massage rolls.

The FOOT MASSAGE, VIBRATION and HEAT functions can be individually switched on and off.

To tailor the massage to your needs even more, the automated programs can also be used in combination with the following programs: STRETCH, ROCKING, RESTORE, LIE DOWN, and the UP/DOWN buttons for FOOTREST, BACKREST and ROTATE.

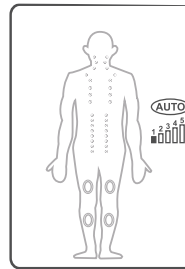

AUTO 1: Full body massage

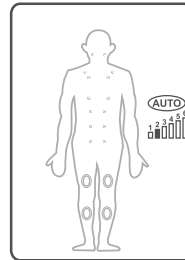

AUTO 2: Regional massage

You can use the buttons UPWARD and DOWNWARD to direct the massage rolls to the region of your back that you would like the massage to be focused on.

Massage and Remote Control Functions

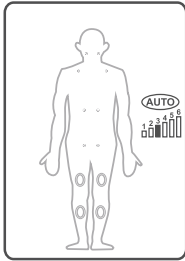

AUTO 3: Fixed Point massage

You can use the buttons UPWARD and DOWNWARD to direct the massage rolls to the specific point on your back that you would like the massage to be focused on.

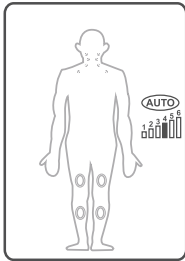

AUTO 4: Head and neck massage

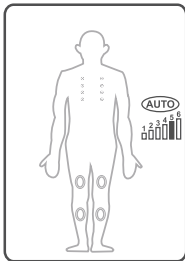

AUTO 5: Upper back massage

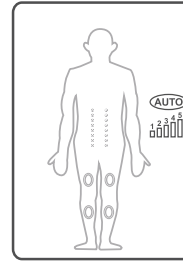

AUTO 6: Lower back massage

3 RELAX RELAX Button

There are five different automatic RELAX full body massage programs. The massage time and chair recline angle is preset and different for each program.

Push this button until the RELAX program of your choice is shown on the display:

- 1 – 38 minutes – slight recline
 - 2 – 30 minutes – medium recline
 - 3 – 15 minutes – deep recline
 - 4 – 10 minutes – very deep recline
 - 5 – 6 minutes – demo version, various recline angles.
- Prior to the massage, the massage rolls move up and down your back to detect your acupressure points.

Massage and Remote Control Functions

4 STRETCH Button

There are four different preset STRETCH positions.

Push this button until the position of your choice is shown on the display:

- E1** – Zero Gravity position for the most comfortable sitting angle
- E2** – V-angle position for a full body stretch
- E3** – A-angle position for a lumbar stretch
- E4** – Inversion stretch position for elevating the feet above the head in order to release any pressure from your legs and to stimulate the blood flow to your heart.
- E5** – Stops **E1, E2, E3 and E4**. The chair returns to its starting position, while the selected massage is continued.

5 ROCKING Button

There are four different preset ROCKING programs. **d1–d3** can be used in combination with AUTO programs and manual massage settings. At the end of each program, the chair and the massage rolls automatically return

to their starting position. Push this button until the program of your choice is shown on the display:

- d1 – deep recline (without rocking):** The chair will automatically go into the deep recline position.
- d2 – medium recline (with rocking):** The chair will automatically go into the medium recline position and will gently rock you back and forth.
- d3 – deep recline (with rocking):** The chair will automatically go into the deep recline position and will gently rock you back and forth.
- d0 – fixed recline:** By selecting d0 you can stop the chair in any of the ROCKING programs' reclined positions: d1, d2 or d3.

6 RESTORE Button

If you push the RESTORE button, the chair automatically returns to its starting position.

7 LIE DOWN Button

If you push the LIE DOWN button, the chair automatically reclines backwards.

Massage and Remote Control Functions

8



ROTATE Buttons

By holding down the buttons UP or DOWN you can rotate the chair to the desired angle.



CAUTION: Make sure that you stay in the position shown only for as long as feels comfortable.

9



BACKREST Buttons

By holding down the buttons UP or DOWN you can adjust the backrest of the chair to the desired angle. If you push the buttons twice quickly, the backrest automatically moves all the way up or down.

10



FOOTREST Buttons

By holding down the buttons UP or DOWN you can adjust the calfrest to the desired angle. If you push the buttons twice quickly, the calfrest automatically moves all the way up or down.

PLEASE NOTE:

The functions 6–10 do not work in combination with the RELAX programs 4 (10 min.) and 5 (6 min.).

11



MANUAL / TIME Button

To select any manual function, first set the desired time with the MANUAL/TIME button. Push this button until the time of your choice is shown on the display: 5 / 10 / 20 / 30 minutes. Then you can select KNEADING, TAPPING, MULTIPLE or SHIATSU. Additionally, you can combine these functions with HEAT, VIBRATION and the CALF MASSAGE options.

Massage and Remote Control Functions

12 **HEAT** HEAT Button

Push this button to select or deselect the HEAT function in the backrest of the chair.

Push this button until the time of your choice is shown on the display – the longer the function is turned on for, the more the chair will heat up.

H1 – 5 minutes

H2 – 10 minutes

H3 – 15 minutes

H0 – off

This function can be turned on and off during all automatic programs and manual massage functions.

13 **VIBRATION** VIBRATION Button

Push this button to select or deselect three different VIBRATION settings for the seat and side panels of the chair. This function can be turned on and off during all automatic programs and manual massage functions.

14 **KNEADING** KNEADING Button (kneading massage):

Push this button to select or deselect the kneading massage in the backrest of the chair. It can be combined with all other manual functions except for WIDTH. KNEADING is preset at speed 1. You can adjust the massage speed to your preference with the SPEED button.

15 **TAPPING** TAPPING Button (tapping massage):

Push this button to select or deselect the TAPPING massage in the backrest of the chair. Press it until the tapping rhythm of your choice is shown on the display: A1 (normal), A2 (with interval), A3 (fast). It can be combined with all other manual functions. You can adjust the massage speed to your preference with the SPEED button and the space between the massage rolls with the WIDTH button. A2 can only be adjusted to three different speed levels and for A3, the speed cannot be changed.

16 **MULTIPLE** MULTIPLE Button (Combination of kneading and tapping massage):

Push this button to select or deselect a combination of kneading and tapping massages in the backrest of the chair. It can be combined with all other manual functions except for WIDTH. The MULTIPLE massage is preset at speed 1. You can adjust the massage speed to your preference with the SPEED button.



Massage and Remote Control Functions

17  **SHIATSU Button**
Push this button to select or deselect a SHIATSU massage for the whole back.

18  **CON. / REP. Button**
There are six different preset positions of the massage rolls. Push this button until the position of your choice is shown on the display: "fixed point", "fixed area", "full body", "neck", "upper back", "lower back". Then select the desired manual massage function: KNEADING, TAPPING, MULTIPLE or SHIATSU. If you choose "fixed point" or "fixed area" massage position, you can use the UPWARD and DOWNWARD buttons to position the massage rolls precisely.

19  **WIDTH Button (space between the massage rolls)**
Push this button to adjust the space between your spine and the massage rolls. You can choose between four different settings: narrow / medium / wide / interval. WIDTH only works in combination with TAPPING.

20  **SPEED Button**
Push this button to adjust the massage speed of the manual massage functions. You can choose between six different SPEED settings for KNEADING, TAPPING and MULTIPLE. The speed of SHIATSU cannot be changed. When running the AUTO and RELAX programs, different speed settings are already preset.

21   **UPWARD / DOWNWARD Buttons**
You can use these buttons to position the massage rolls precisely if you have chosen the "fixed point" or "fixed area" massage position of the CON. / REP. function (see button 18).

22  **KNEADING Button (calf kneading massage)**
Push this button to select or deselect the kneading massage in the calfrest. Press it until the desired speed is shown on the display: F1, F2, F3 - or F0 to stop the massage.

Massage and Remote Control Functions

- 23 **SWING** **SWING Button (Calf swing massage)**
Push this button to select or deselect the SWING massage in the calfrest. Press it until the desired speed is shown on the display: F1, F2, F3 – or F0 to stop the massage.
- 24 **AUTO** **AUTO Button (Automated calf massage)**
Push this button to select (FA) or deselect (F0) an automated combination of KNEADING and SWING massages in the calfrest.



General Instructions for Use

Plug in the power cord and then turn on the chair with the ON / OFF switch on the right side of the backrest. Decide between the automatic massage programs and the manual massage functions.

MANUAL MESSAGE FUNCTIONS:

Use the MANUAL / TIME button to first set the desired message time, then select one of the following functions: KNEADING, TAPPING, MULTIPLE or SHIATSU. You can now adjust the speed of KNEADING, TAPPING and MULTIPLE with the SPEED button. For the TAPPING function you can additionally adjust the space between the massage rolls with the WIDTH button. If you have chosen the "fixed point" or "fixed area" massage position with the CON. / REP. button, you can now position the massage rolls precisely with the UPWARD and DOWNWARD buttons.

AUTOMATIC MESSAGE FUNCTIONS:

You can select six different automatic massage programs with the AUTO button and five different automatic programs with the RELAX button. In addition, you can select VIBRATION and the AUTO calf massage function by using the corresponding buttons.

ADDITIONAL FUNCTIONS:

VIBRATION and HEAT can be selected and deselected individually for all AUTO, RELAX and MANUAL programs.

STOPPING THE MESSAGE:

Push the STOP button to stop any message program. The chair and the massage rolls will automatically return to their starting position. When finished, please turn off your massage chair and unplug the power cord.

The intensity of the massage can be increased by removing the foam insert from the backrest pad. If you would like to decrease the massage intensity, you can purchase our massage chair overlay.

Please use a surge protector to protect your chair from current fluctuations.

Troubleshooting, Maintenance & Care

PROBLEM: No power

1. Make sure the chair is switched on. The ON / OFF switch is located on the right side of the backrest. The icon "-" has to be pushed inwards. If you still have no power, continue with step 2.
2. Check both ends of the power cord and make sure it is securely plugged into the chair as well as into the wall outlet. If you still have no power, continue with step 3.
3. Test the wall outlet with another appliance. If the outlet works but the chair doesn't, continue with step 4.
4. Exchange the main fuse (7 amps) of the chair (see chapter "Basic Replacement Guide" on page 21).

PROBLEM: Chair responds when buttons are pushed, but features are not shown on the remote control display

1. Turn off the chair. The power switch is located on the right side of the backrest. The icon "o" has to be pushed inwards.
2. Unplug the power cord for 10 seconds.
3. Plug the power cord back in.

4. Turn the chair back on – the icon "-" has to be pushed inwards. If the display still doesn't work, continue with step 5.
5. Check that both ends of the cable between remote control and chair are connected securely. For this, you have to unscrew the remote control cover (5 screws on the back).

PROBLEM: When reclining, the chair makes a squeaking noise

1. First, determine which function is making the squeaking noise by testing each of the recline motors with the corresponding UP / DOWN buttons: FOOTREST, BACKREST and ROTATE.
2. Once you have determined which motor makes the squeaking noise, lubricate the point where the rod moves in and out with WD-40 or 3-IN-ONE oil. The motors are located underneath the chair. If the chair still squeaks, continue with step 3.
3. Use WD-40 or 3-IN-ONE oil to lubricate the side bolts that connect the backrest with the seat frame of the chair. These bolts are located between the backrest and the side panels of the chair.

Troubleshooting, Maintenance & Care

BASIC REPLACEMENT GUIDE

PLEASE NOTE: Always turn off the chair and unplug the power cord from the wall outlet when replacing any part/s.

How to Replace the Main Fuse (near the ON / OFF switch):

- Unplug the power cord from the chair itself (Picture 2).
- Use a small flathead screwdriver to carefully unhinge the fuse cartridge and pull it out (Pictures 3-5).
- Replace the fuse in the clamp (fuse currently in use) with the fuse in the square enclosure (spare fuse). Additional fuses (7 amps) can be purchased at any local electrical shop (Picture 6).
- Push the cartridge with the new fuse back into place.
- Plug the power cord back into to the chair.
- Test whether the chair works. You should hear a "beep" when you switch on the chair.



Picture 1:
Right side view of the chair.

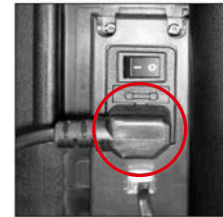

Picture 2:
Remove the power cord.

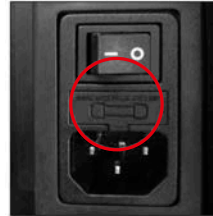

Picture 3:
Fuse cartridge.



Picture 4:
Unhinge the fuse cartridge with a flathead screwdriver.



Picture 5:
The fuse cartridge slides out towards you.

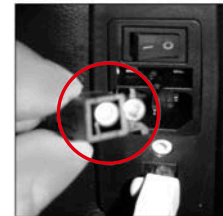

Picture 6:
Damaged main fuse (right) and spare fuse (left).

Troubleshooting, Maintenance & Care

CLEANING AND CARE of Chair and Remote Control

CAUTION:

Switch off the chair and unplug the power cord from the socket before cleaning the chair and remote control. Only clean the outside of the chair! Use a soft cloth to brush dust off the chair parts that are not covered in (artificial) leather. The remote control can be gently wiped with a slightly moist cloth and dried with a dry soft cloth. By default, the massage chair is upholstered with artificial leather. Therefore, it can be easily cleaned and, if necessary, also disinfected.

CLEANING THE ARTIFICIAL LEATHER COVER of the Chair

BASICS

Artificial leather is a comparatively hard-wearing material. The following cleaning and care advice is aimed at preserving the appearance and quality of your massage chair:

- As is true for all upholstered furniture, the cover material of your massage chair can fade or wear out

more quickly by being exposed to direct sunlight or heat (for example by being placed next to a radiator). If your chair is placed by a window, please use curtains or blinds.

- Over time, artificial leather loses its plasticizers and can become dry and brittle. This process cannot be prevented but can be delayed by treating your massage chair with care and cleaning it regularly. It is also possible to have your chair fully or partly replaced by us (prices on request).

CLEANING AND CARE

Step 1: Moisten a soft cloth with lukewarm water, which contains a mild cleaning detergent (do not use solvents or abrasive products – please see the cleaning product recommendations on our website). The cloth should only be slightly moist. Wipe the chair down by moving from one area (enclosed by seams) to the next; move from the edges towards the center with circular motions.

Step 2: Afterwards, repeat the process with a soft cloth that is moistened with lukewarm water without any cleaning detergent.

Step 3: Dry the cover with another dry, soft cloth.

Product Specifications

REMOVING STAINS AND DIRT:

- The quicker you remove dirt or stains, the better the result.
- Absorb spilled liquids with a soft cloth and subsequently clean the affected area in three steps as described on the previous page.
- Do not scrape off dried-up dirt, but carefully push it off with a blunt object (such as the blunt side of a knife) and subsequently clean the affected area in three steps as described on the previous page.
- You can use a soft brush to treat tougher stains. Wet the brush with lukewarm water, which contains a mild cleaning detergent (do not use solvents or abrasive products – please see the cleaning product recommendations on our website). Then, clean the affected area in three steps as described on the previous page.

PLEASE NOTE: The advice given does not constitute a guarantee and does not exempt you from your duty to exercise diligence with your massage chair and the cleaning products you use. We assume no liability for any damage occurring during and/or from the cleaning and care of the chair.

Product Specifications

Product name:

brainLight-Shiatsu-Massage-Chair Gravity PLUS

Vertical range of the massage rolls: 69 cm (approx. 2.3 ft)

Position angles of the chair: 116° – 183°

Operating voltage: AC 100 – 240 V; 50 – 60 Hz

Wattage: 60 – 100 W

Motor voltage: 24 V AC

Weight: 77 kg +/- 3 kg



Dimensions: approx. L 114 cm x W 97 cm x H 117 cm /
approx. L 3.7 ft x W 3.2 ft x H 3.8 ft

Dimensions when chair is fully reclined and calf-rest horizontal: approx. L 178 cm x W 97 cm x H 86 cm /
approx. L 5.8 ft x W 3.2 ft x H 2.8 ft

When combined with the **brainLight** relaxTower or the **brainLight**-Synchro PRO, the **brainLight**-Shiatsu-Massage-Chair Gravity PLUS can be upgraded to a **brainLight**-Complete-System for holistic relaxation of mind and body (<https://www.brainlight.com/products/brainlight-complete-systems-e/>). Please visit www.brainlight.com/bl-support/faq-e.html for frequently asked questions (FAQs) and for technical and product information available for download.

Relaxation technology Made in Germany!



brainLight GmbH • Hauptstraße 52 • 63773 Goldbach • Germany
 Phone: +49 (0) 6021 59070 • Telefax: +49 (0) 6021 540997 • E-Mail: info@brainlight.de
www.brainlight.de + www.brainlight.com

brainLight®

LIFE IN BALANCE

◆◆◆ Est. 1988 ◆◆◆